Novaclean ISF Automatic Iron & Sulfur Filters



Operation Manual

*Page 5 of this manual contains important maintenance procedures for the continued proper operation of your unit. These **MUST** be performed regularly for your guarantee to remain valid.*

Novaclean ISF Specifications

Model Description	Manganese Greensand Cu Ft	Pot Perm* per Regen Ounces	Iron Removal Capacity ppm	Flow Rates USGPM		Installation Space - Inches W x D x H	Fiberglass Tank Size Inches	Shipping Weight Lbs
				Service	Backwash			
NMGF75MI	.75	2	4,500	4	3.5	20 x 10 x 57	8 x 47	120
NMGF10MI	1.0	4	6,000	5	5	22 x 12 x 57	10 x 47	150
NMGF15MI	1.5	6	9,000	8	7	24 x 14 x 62	12 x 52	180
NMGF20MI	2.0	8	12,000	10	10	26 x 16 x 60	14 x 50	265

* Potassium permanganate sold separately.

- Peak flow rates intended for intermittent use only (10 minutes or less) and are for residential applications only. Do not use peak flow rates for commercial applications.
- At the stated flow rates, the pressure drop through these devices will not exceed 15 psig.
- For satisfactory operation, the pumping rate of the well system must equal or exceed indicated backwash flow rate.

- Maximum Water Temperature = 110°F (43°C)
- Maximum Operating Pressure = 100 PSIG (689 kPa)
- Pipe Size = 3/4"
- Voltage = 110V Standard
- The manufacturer reserves the right to make product improvements which may deviate from the specifications and descriptions stated herein, without obligation to change previously manufactured products or to note the change.

Sizing & Operating Requirements

Water Pressure - The water system must have a pump big enough to deliver the recommended backwash rate with a minimum pressure at the inlet of the filter of 20 psi (139.9 kPa). If the existing system cannot do this, it must be upgraded to do so. Whenever possible, the water system should be adjusted to deliver at least 30 psi (206.8 kPa) for even more satisfactory results. Maximum pressure should not exceed 120 psi (827.4 kPa).

Backwash Flow Rates - The most important criteria in sizing an iron filter is the capacity of the pump. The water must pass through the filter media at a service flow rate that allows it to oxidize and collect the iron. The filter must also be backwashed at a flow rate sufficient to dislodge and remove the captured iron. Failure to provide sufficient water will cause a build-up of iron in the filter media, impairing its iron removing ability and resulting in iron bleeding out into the service water.

In order for your filter to backwash and rinse properly, your pump must be capable of providing the backwash flow rates indicated in the above specification chart.

Capacity - An iron filter with one cubic foot of filter media regenerated with 4 oz. of potassium permanganate will work well for most residential applications. For example, with iron in the range of 3-6 ppm, most filters will need to regenerate every two to three days providing an average family size of four or five people.

The specification chart above shows the iron removal capacity in ppm that can be expected on automatic iron filters. The specifications are based on obtaining 6,000 ppm of capacity for each cubic foot of filter media.

In order to obtain the above capacities, the pH of the water being treated must be 7.0 or above. In the even the water is below 7.0 it must be treated with the appropriate equipment before getting through the filter.

Removal Of Iron, Sulfur & Manganese

For the purpose of sizing a filter, consider 1 ppm of manganese equal to 2 ppm of iron and 1 ppm of sulfur equal to 3 ppm of iron. Manganese and hydrogen sulfide (sulfur) are more difficult to oxidize than iron. Therefore, we suggest that, when making your sizing calculations and regeneration frequency calculations, you calculate iron as 1, manganese x 2 and sulfur x 3. All three must equal less than 10 ppm. Manganese is often present in water when iron is present. Hydrogen sulfide can normally be identified by a strong rotten egg odor.

Typical Installation

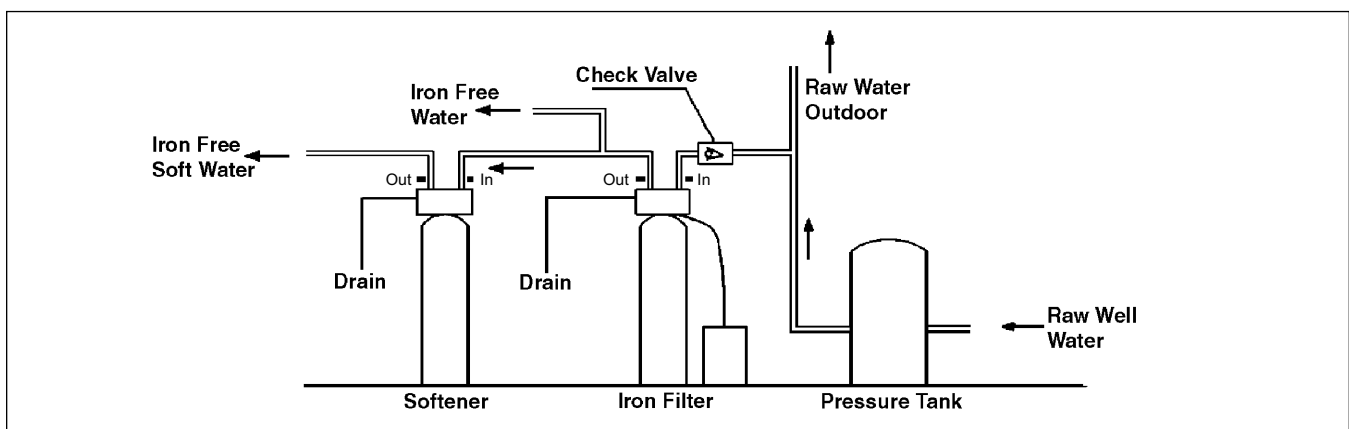

Installation Instructions

CAUTION:

If the ground from the electrical panel or breaker box to the water meter or underground copper pipe is tied to the copper water lines and these lines are cut during installation of the Noryl bypass valve and/or poly pipe, an approved grounding strap must be used between the two lines that have been cut in order to maintain continuity. The length of the grounding strap will depend upon the number of units being installed and/or the amount of copper pipe being replaced with poly. See Figure 1.

In all cases where metal pipe was originally used and is later interrupted by poly pipe or the Noryl bypass valve, as in Figure 1 or by physical separation as in Figure 2, to maintain proper metallic pipe bonding, an approved ground clamp c/w not less than #6 copper conductor must be used for continuity.

Check your local electrical code for the correct clamp and cable size.

- Place iron filter with chemical feeder container on a flat surface in desired location, near a drain and 115 volt AC outlet. Subjecting your filter to freezing or to water temperatures above 120°F (49°C) will void the warranty. Remove the valve from the carton. Be sure the distributor tube is in place. Carefully position the valve over it and turn securely on to the fiberglass tank. Larger units may need to be filled prior to the valve being put on, see Filling Instructions on page 7.

- Attach the installation kit or bypass to the control valve. Make inlet and outlet water connections to meet applicable plumbing codes. A 3/4" inlet line is recommended. When sweat fittings are used, solder the adapters for the inlet and outlet to the copper pipe first. This procedure is necessary because the controls **must not** be subjected to temperatures above 160°F (71°C). Then, using teflon tape, screw the adapters for the inlet, outlet and drain into the valve. CAUTION: do not use pipe thread compound as it may attack the materials in the valve body.
- On the drain, use the 1/2" hose barb supplied and a full 1/2" ID hose (not supplied) for the drain line and make the shortest run to a suitable drain. The drain line must be secured in position at the end which discharges into the drain so it cannot be inadvertently moved from the drain, resulting in chemical spillage, as shown in Figure 3.
- Connect the feeder container to the control valve with the flexible polyethylene tube supplied. The connection to the container is made with the fitting nut provided (do not over tighten).

The 2 CF filters are supplied with two potassium permanganate feeders. Both of the feeders need to be connected by a Tee and tubing as shown in Figure 4.

- Attach the 5/8" hose (supplied) to the over flow fitting on the feeder and run the hose to the floor drain.

ALL GOVERNMENT CODES GOVERNING INSTALLATIONS OF THESE DEVICES MUST BE OBSERVED.

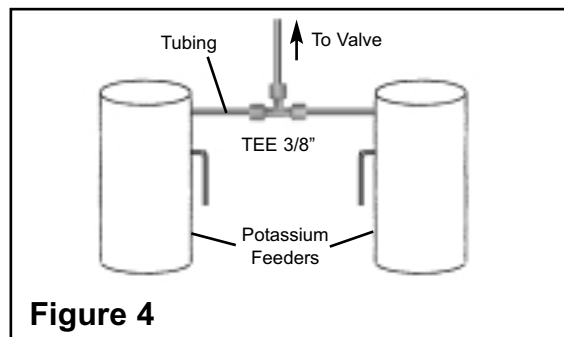
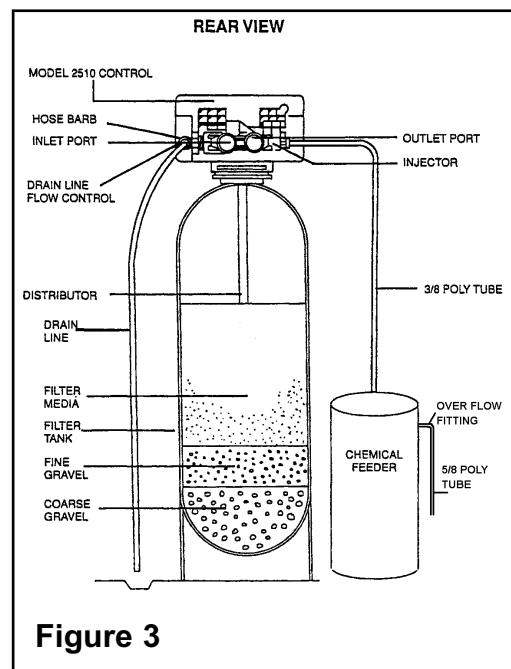
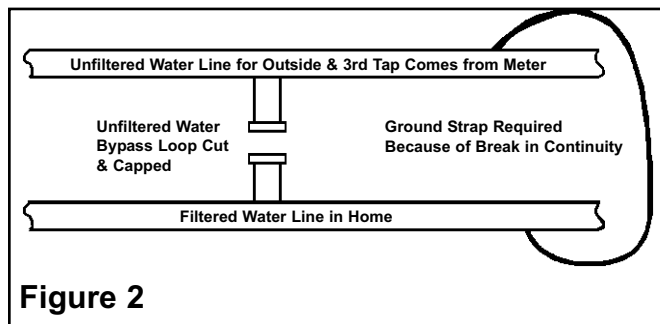
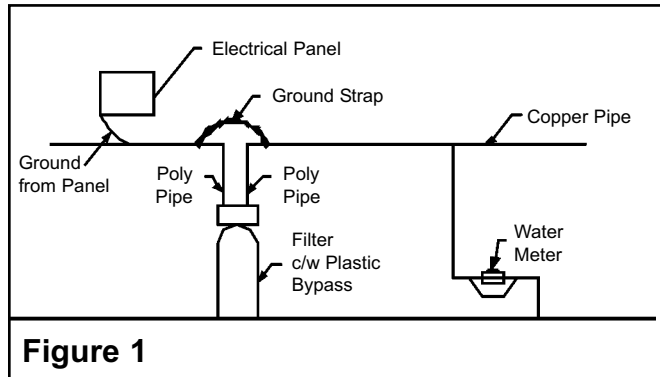

Start-Up Procedure

(see installation instructions)

CAUTION: The timer programs will be out of sync if you turn the knob too far or do not allow the drive motor to stop completely before continuing to the next step. If this happens, rotate the Manual Regeneration knob clockwise until the raised dot lines up with the time of day arrow and the unit returns to the service position. Then start again.

1. Loosen the two screws on the timer cover to remove it from the timer.
2. Pull on the top left corner of the black timer to open it and reveal the program wheel.
3. The Novaclean ISF filter is supplied from the factory in the backwash position, ready for start up. Turn on the water supply to the unit. Open the supply line slowly and allow the air to escape from the filter before turning the supply water on all the way. Allow the unit to backwash until all the air has escaped and media fines are no longer showing at the drain. This may take up to 15 minutes so do not supply power to the timer until this procedure is complete.
4. Plug the timer in and advance the Manual Regeneration knob on the front (with the raised dot on it) clockwise until the switch comes off the pins. Allow the drive motor to run until it stops. The unit is now in the draw position. Verify that there is draw by placing your finger over the hole where you will be attaching the potassium feeder to the control valve assembly on the back of the timer plate.
5. Advance the Manual Regeneration knob clockwise again until the switch is on the next set of pins. Allow the drive motor to run until it stops. This is the rapid rinse position. If there is no more air escaping to the drain line, you can continue on to the next set of spaces. Allow the motor to stop driving before turning any further. This is the refill position. Allow the unit to refill until there is water above the grid pad in the potassium container. (Be sure to read the instructions on the potassium container before connecting it to the unit).
6. Advance the Manual Regeneration knob clockwise again until the raised dot lines up with the time of day arrow on the front. Allow the motor to run until it stops. This is the service position.
7. Set the time of day and the frequency of regeneration following the instructions on page 4.
8. Cautiously pour the potassium permanganate into the feeder and replace the cover and safety screws. See instructions on Page 7 when refilling is required.
9. Allow 1 hour for the potassium to saturate and then initiate a manual regeneration to activate the manganese greensand. For manual initiation, turn the Manual Regeneration knob clockwise to the first set of pins and allow the unit to continue from there.

Operating Instructions

Your automatic iron filter is an ingeniously simple and reliable design. The unit consists of a bed of filter media contained in a fiberglass tank, a specially designed feeder containing potassium permanganate for the regeneration of the filter and a proven 6-cycle automatic control.

Raw water enters your home through the main supply line, enters your iron filter and passes down through the filter media. Any iron, manganese or sulfur present in your water supply is exposed to oxygen stored in the filter media. The oxygen causes precipitation of the minerals and they are trapped in the filter media. Only clean, filtered water flows to your household water line. The filter media is periodically regenerated, automatically backwashing the trapped minerals to the drain and replacing the oxygen. This is done by introducing potassium permanganate to the media.

1. Your automatic iron filter can be programmed to operate according to your needs by making the appropriate settings on the 24-hour timer and program wheel. On the days your filter regenerates, the operating cycles will be automatically performed. In the service position, filtered water is supplied for household use.
2. The automatic control reverses the flow of the water through the filter, backwashing minerals trapped in the filter to the drain.
3. The control pulls a vacuum on the feeder and draws saturated potassium permanganate solution into the filter tank.
4. The control slowly rinses the chemical through the media tank. The potassium permanganate supplies oxygen to the filter media.
5. The control fast rinses the media bed to settle it and to ensure that all the chemical and mineral precipitate is removed.
6. The control adds water to refill the feeder to the proper level. The feeder is now ready for the next regeneration. The control puts the system into service, supplying iron-free water to the household. All this is performed automatically over a period of approximately 90 minutes. Water does not continuously run to drain for approximately 90 minutes.

Setting the 24-Hour Timer

Press and hold the red button in to disengage the drive gear. Turn the large dial until the actual time of day is opposite the time of day pointer. Release the red button to re-engage the drive gear

Frequency of Automatic Regeneration

Setting the Program Wheel (Figure 5)

The number of gallons of filtered water your iron filter can supply between regenerations must first be determined using the following calculations:

ppm of capacity between regenerations (See Specs - Page 1)

÷ ppm of iron in the water sample

= number of gallons supplied between regenerations

- reserve capacity (number of people x 60 gallons)

EXAMPLE - Using NMGF10MI + 1 Feeder

6000 ppm between regenerations

÷ 8 ppm of iron

= 750 gallons between regenerations

- 300 gallons reserve capacity (5 people x 60 gallons)

= 450 GALLONS - SETTING ON PROGRAM WHEEL

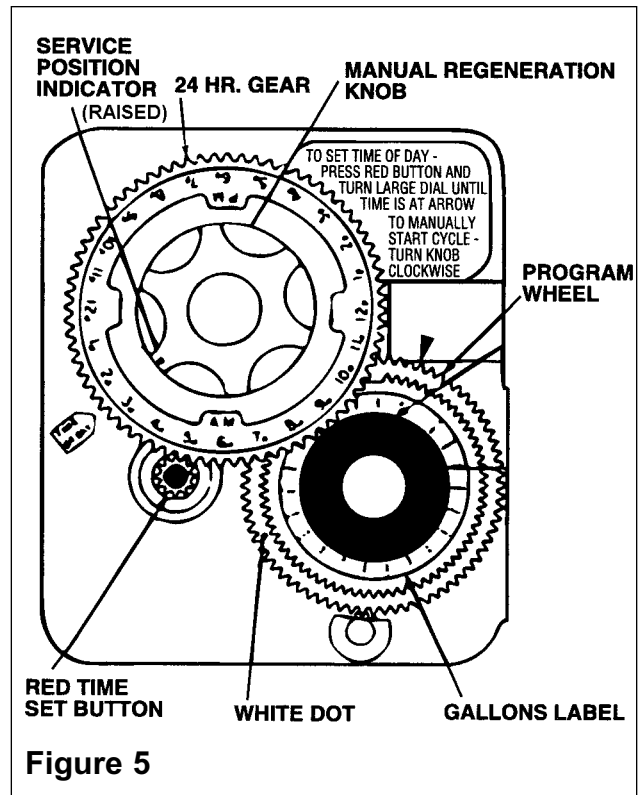

To obtain this setting, grasp the program wheel and, while pulling it towards you, turn it until the number of gallons is aligned with the white dot on the circumference. Release the dial and check for firm engagement at setting.

Manual Bypass (Figure 6A)

In case of an emergency, you can isolate your water filter from the water supply using the bypass valve located at the back of the control.

In normal operation the bypass is open with the on/off knobs in line with the inlet and outlet pipes. To isolate the filter, simply rotate the knobs clockwise (as indicated by the word BYPASS and arrow) until they lock.

You can use your water related fixtures and appliances as the water supply is bypassing the filter. However, the water you use will be unfiltered.

To resume filtered water service, open the bypass valve by rotating the knobs counter-clockwise.

PLEASE NOTE: THE FOLLOWING MAINTENANCE PROCEDURES MUST BE PERFORMED REGULARLY FOR YOUR GUARANTEE TO BE VALID.

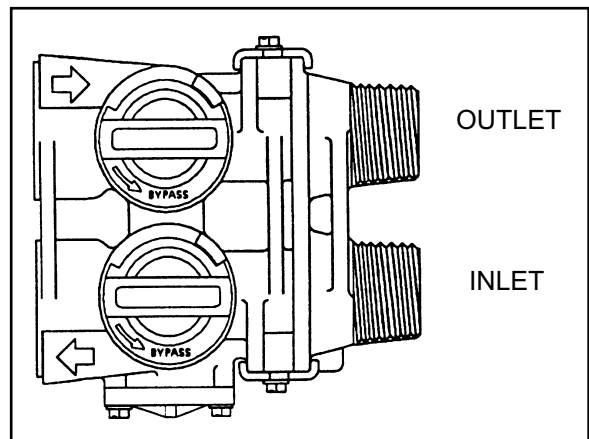

Figure 6A

Stainless Steel Bypass (Figure 6B)

In normal operation the bypass lever is aligned with the inlet/outlet with the pointer on SERVICE. To isolate the filter, rotate lever counter clockwise until it stops and pointer indicates unit is in bypass.

You can use your water related fixtures and appliances as the water supply is bypassing the filter. However, the water you use will be unfiltered.

To resume filtered water service, open the bypass valve by reversing the rotation of the lever.

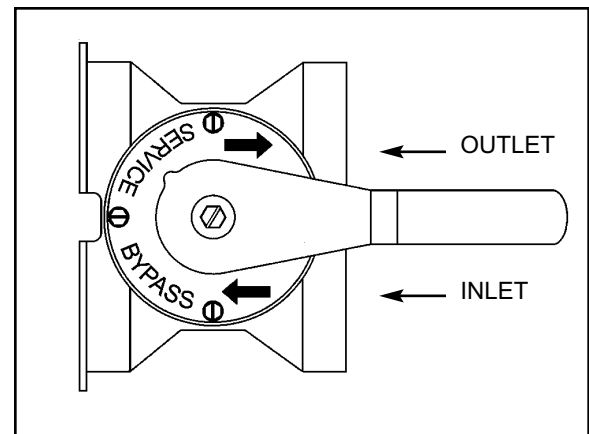

Figure 6B

Cleaning The Injector Assembly (Figure 7)

The presence of iron and sediment will restrict and clog the injector assembly which is located on the top of the main control valve. This assembly is very easy to clean.

Shut off the water supply to your unit and reduce the pressure by turning the large knob to backwash. Using a screwdriver, and a pair of pliers remove the injector assembly from the control valve body. Carefully remove the assembly and disassemble as shown in Figure 7.

The injector nozzle is removed from the valve body by carefully turning it out with a large screwdriver. Remove the injector throat the same way. Carefully flush all parts with water. Use a mild acid such as vinegar or Pro-Rust Out to clear the small holes in the nozzle and throat. Reassemble using the reverse procedure.

Care Of Your Filter

Your filter tank and chemical feeder container can be cleaned with a mild soap solution. Never subjected the unit to freezing or to temperatures above 120°F. Do not strike or drop the chemical feeder container. If the container is found to be leaking, shut off the water supply to your filter and replace the container at once.

Sounds

You will notice new sounds as your filter operates such as the hum of the timer or click of the actuator arm. During regeneration, it will not be uncommon to hear the sounds of water running to the drain.

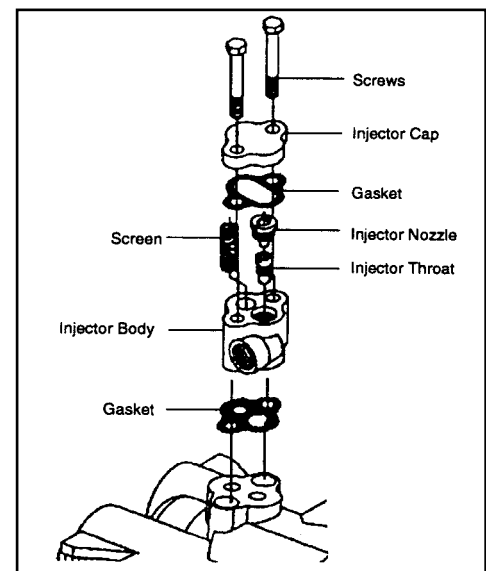

Figure 7

Potassium Permanganate Feeder

The potassium permanganate feeder assembly incorporates a non-pressurized storage tank and innovative grid design along with a dependable float valve.

The attractive 10" x 16" black tank is made of touch blow-molded high density polyethylene. It has a potassium permanganate capacity of 30 lbs. and a liquid capacity of 5 gallons.

The black injection molded cover is securely fastened with three stainless steel safety screws to prevent access by children and pets. Also, the potassium chemical tank should be placed where it is free from possible upset or access by children or pets.

Chemical warning label and drain caution label are affixed to unit.

The unique polypropylene grid pad refuses to allow even the finest grade of undissolved potassium permanganate to pass through the grid. This permits efficient use of our assembly with all grades of potassium permanganate. Standard grid platform height is 6". Additional heights are available - consult factory.

The unit is shipped fully tested and assembled and weighs approximately 7 lbs. The feeder assembly includes:

- | | | |
|---|----------------------------------|-------------------------------------|
| 10" x 16" black tank | 1/4" PVC riser pipe | 4 ft of 1/4" or 3/8" suction tubing |
| 3 Stainless steel safety screws | Black injection molded cover | 1/2" Overflow fitting |
| 4" Well and cap | Grid with polypropylene grid pad | 1/4" or 3/8" poly tube elbow |
| 15 ft of 5/8" x 1/2" poly drain tubing* | Float valve | |
| Drain caution label | Chemical warning label | |

The potassium storage tank placement should be such to permit the installation of the overflow line to a permanent drain facility.

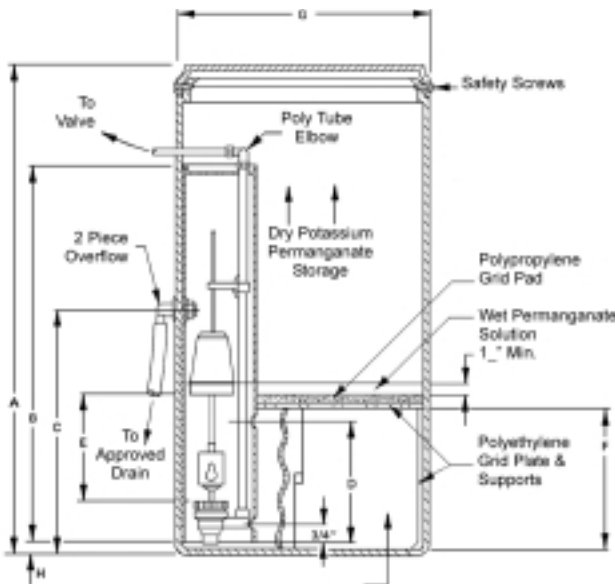

Dimensions - Inches

- A = 16-1/2"
- B = 14-1/2"
- C = 10-1/2"
- D = 5-1/4"
- E = See Table
- F = 5-3/4" (2 oz. to 4 oz.)
7-5/8" (6 oz.)
- G = 10-1/2"
- H = 1/8"

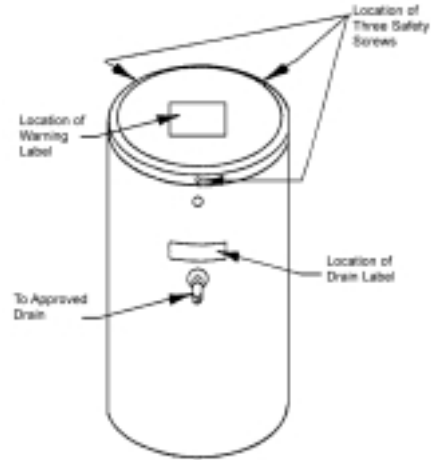

Correct water temperature is important for obtaining properly dissolved potassium permanganate.

Tables based on permanganate solubility of 4 oz/gal at 50°F or 8 oz/gal at 72°F.

Float setting is based on distance between brine valve top body nut and the bottom of the float with the valve in the closed (float up) position.

All dimensions nearest 1/4 inch.

Oz. Of Potassium Permanganate	Gallons of Solution	Float Setting	Riser Pipe Length
2	3/4	2 1/2	11
4	1	4	12 1/2
6	1-1/2	5-5/8	12-1/2

Iron and Manganese Removal

A recommended dose of 2 oz. to 6 oz. of potassium permanganate per cubic foot of manganese greensand is suggested for regeneration. Correct water temperature is important in obtaining proper dissolving of potassium permanganate. At 50°F (10°C), 4 oz. of potassium permanganate can dissolve in one gallon of water. At room temperature 72°F (22°C), 8 oz. will dissolve in one gallon of water.

Potassium Permanganate

Potassium permanganate refills in 10 lb. (4.5 kg) packages can be obtained from your dealer. Exercise care when handling potassium permanganate. Wear rubber gloves and avoid contact with skin or clothing. Avoid inhaling. Clean any spillage immediately. Stains can be cleaned with a mild solution of sodium hydrosulfite (Pro-Rust Out).

Installation & Replacement of Filter Media Pak

Replacement of Filter Media Pak should be performed every 3 to 5 years or if the media bed has ever become stripped.

Check to ensure all media parts are received.

The first step in replacing the media bed is to shut off the water supply to the filter. Then place the unit into the backwash position to release any pressure in the lines. At this point, you must disconnect the plumbing from the inlet and outlet. Then unscrew the control valve (Item A) from the fiberglass tank. Once this has been done, remove the distributor tube (Item B). Then you can remove the filter media and two types of gravel from the tank. The quickest way to do this is by simply tipping the tank upside down into a large drum or pail. The tank must be rinsed out completely and have no media or gravel left in it at all.

Loading the Media-Pak

Place the distributor tube (Item B) back down the center of the tank. Note: The top of this tube should be plugged with a rag or cork to prevent media (Item C) from entering. Pour the bag of coarse gravel (Item E) into the tank, then pour the bag of fine gravel (Item D) into the tank. The final step is to add the Filter Media (Item C).

It is important that the distributor tube is not moved or pulled out as it would not be possible to put it down to the bottom of the tank once gravel or media are in the tank.

Once this is done, the rag or cork should be removed from the distributor tube. Clean off the top of the tank. Finally place the control valve on the tank and onto the distributor tube. Tighten the control valve onto the tank. Connect or reconnect the inlet and outlet and drain. The control valve should be in the backwash position. Slowly open the inlet valve water supply and slowly fill the filter tank until water appears at the open drain line (Item F). Return the control to the service position and shut the inlet off for approximately one hour to allow the media to soak in the water.

After one hour, turn inlet water on slowly and place the control into the backwash position and plug the unit's electrical cord into a constant power source. Let the unit continue through its regeneration cycle automatically.

The regeneration is necessary so all media fines are backwashed down the drain to ensure clean filtered water. After this media has been replaced, it may be necessary to reset the present time of day on the control valve timer as it will have been unplugged for some time.

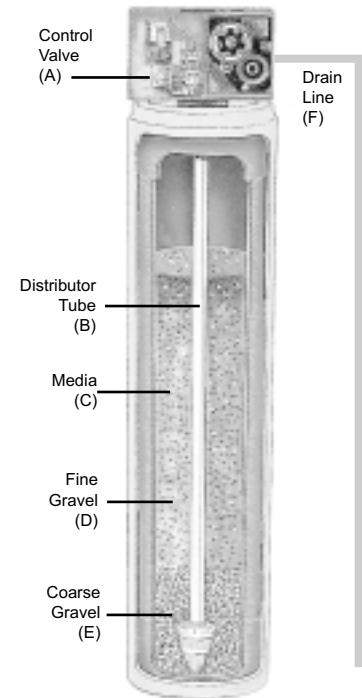

Refilling the Potassium Feeder

The feeder container must be refilled on a regular basis. If granular potassium permanganate cannot be seen on filter pad, potassium permanganate is to be added. If it is not, the media bed can become stripped and therefore will require replacement. Make sure the filter is not in a regeneration cycle when refilling the container.

It is recommended that the injector be removed, checked and cleaned each time the container is refilled.

Refilling of the container is to be done by the local dealer or the homeowner.

Fill the container with dry granular potassium permanganate and install a new filter pad periodically.

USE CAUTION WHEN REFILLING TO AVOID SPLASHING OF THE CHEMICAL

Procedure to Open and Close 2510 Meter Timer Assembly

The purpose of this procedure:

To communicate the steps required to open and close the 2510 meter timer assembly to reduce the amount of strain placed on the meter pod and clutch connections as well as the meter cable itself.

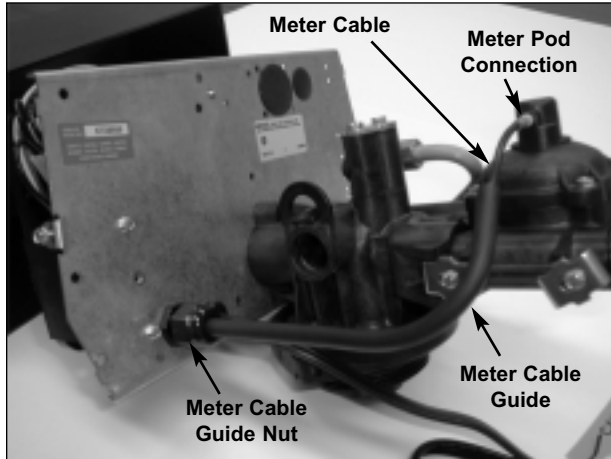

Illustration 1

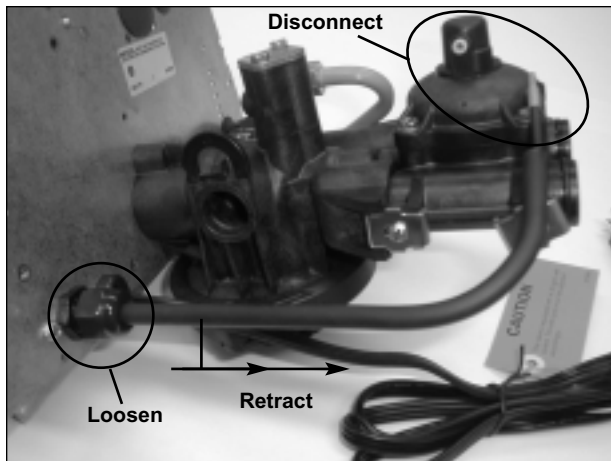

Illustration 2

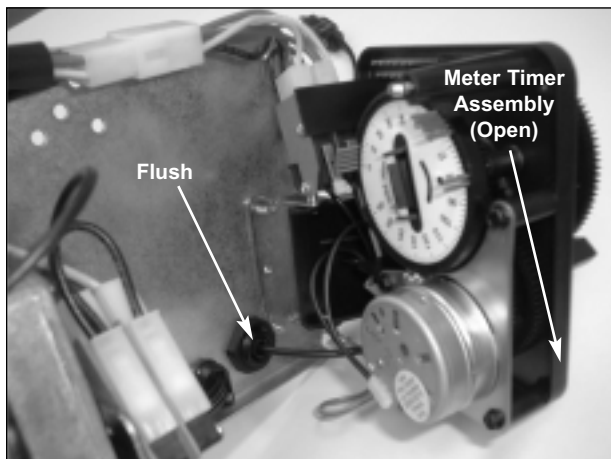

Illustration 3

Please follow instructions in sequential order.

To Open Meter Timer Assembly:

1. Remove cover by loosening screw on each side of cover.
2. Familiarize yourself with the various components (Illustration 1).
3. Loosen Meter Cable Guide Nut (Illustration 2)
4. Disconnect Meter Cable from on Meter Pod Connection by grasping the brass Meter Cable end and pulling straight out.
5. Retract Meter Cable Guide until it is in the position shown in Illustration 2. As the Meter Cable Guide is retracted the Meter Cable will retract inside the Meter Cable Guide.
6. The end of the Meter Cable Guide should be approximately flush with nut on the inside of the backplate which secures the Meter Cable Guide connector to the backplate (Illustration 3).
7. The Meter Timer Assembly can be opened (Illustration 3) by gently pulling on the top of the Meter Timer Assembly nearest the middle of the backplate until the brass clip releases from the backplate. The Meter Cable (Meter Pod end) will retract further inside the Meter Cable Guide as the Meter Timer Assembly is opened.

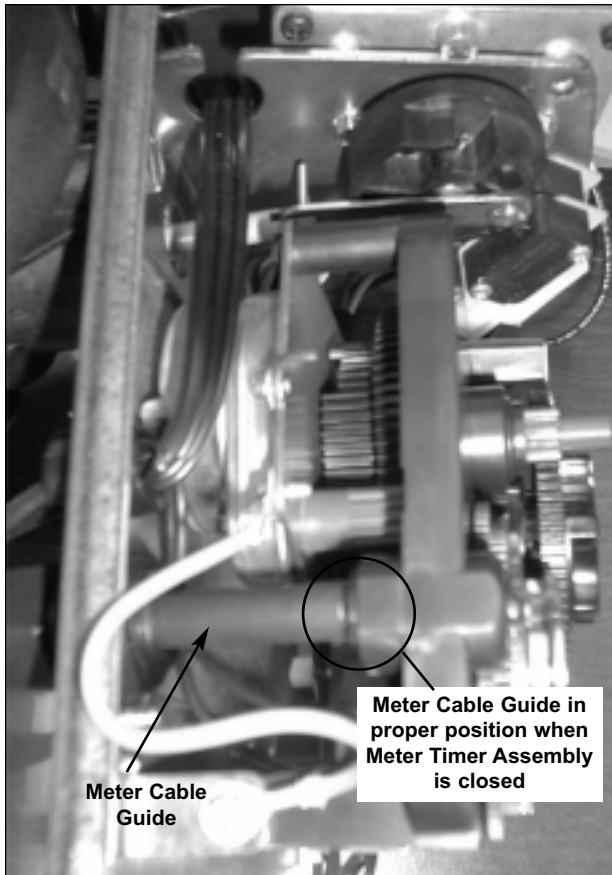

Illustration 4

To Close Meter Timer Assembly:

1. The Meter Timer Assembly can be closed by gently pushing on the top of the Meter Timer Assembly nearest the middle of the backplate until the brass clip engages the backplate. The Meter Cable will protrude further from the Meter Cable Guide (Meter Pod end) as the Meter Timer Assembly is closed
2. With the Meter Timer Assembly closed gently push the Meter Cable Guide towards the Meter Timer Assembly until it stops against the inside of the Meter Timer Assembly. The proper position shown in Illustration 4. As the Meter Cable Guide is pushed toward the Meter Timer Assembly the Meter Cable will protrude further from the Meter Cable Guide (Meter Pod end).
3. Align the Meter Cable Guide with the Meter Pod Connection and tighten Meter Cable Guide Nut (Illustration 5)
4. Reconnect the Meter Cable by grasping the brass Meter Cable end and gently pushing it into the Meter Pod Connection. Proper alignment is shown in Illustration 5.
5. Replace cover and tighten screw on each side of cover.

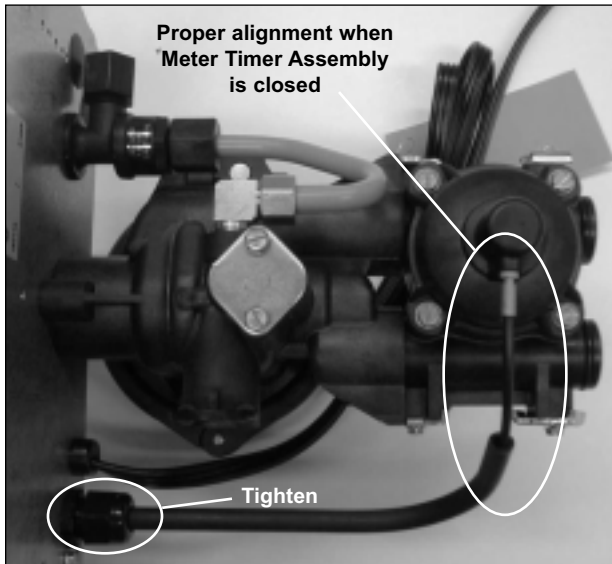

Illustration 5

Trouble Shooting Guide

PROBLEM	CAUSE	CORRECTION
1. FILTER FAILS TO REGENERATE OR REGENERATES AT WRONG TIMES	A. Electrical service to unit has been interrupted B. Timer is defective C. Power failure D. Timer motor does not run	A. Assure permanent electrical service (check fuse, plug or switch) B. Repair or replace timer C. Reset time of day D. Replace defective motor
2. FILTER BLEEDS IRON OR ODOR	A. Bypass valve is open B. Container is depleted C. Excessive water usage D. Insufficient water flowing into chemical container E. Hot water tank rusty F. Leak at distributor tube G. Defective or stripped media bed H. Not backwashing enough I. Internal valve leak J. Electrical Service to unit has K. Control will not draw chemical properly (see below) L. Quality of water has worsened M. Filter capacity is too small	A. Close bypass valve B. Replace or refill container C. Increase frequency of regeneration and/or settings. Make sure there are no leaks in toilets and sinks D. Check refill setting. Check for plugged container tube and flow control E. Repeated flushings of the hot water tank are required. Do not use hot water during regeneration F. Make sure distributor tube is not cracked. Check O-ring and tube pilot G. Replace media H. Be sure flow control is not clogged or drain line restricted. Be sure water pressure has not dropped and that pump has sufficient capacity. I. Replace seals and spacers and/or piston J. Assure permanent electrical service (check been interrupted fuse, plug or switch) K. Maintain water pressure at 20 psi (139.9 kPa) minimum. Clean or replace injector assembly. Check for air leaks along brine line and tighten all connections. L. Have water sample analysed to determine any change M. Replace with larger unit
3. FILTER REGENERATES EVERY DAY	A. Faulty gear train	A. Check the mechanical linkage on the timer control to eliminate possible binding in the gear train.
4. IRON FILTER USES TOO MUCH CHEMICAL	A. Defective chemical container	A. Replace container
5. LOSS OF WATER PRESSURE	A. Iron or turbidity build-up in filter B. Inlet to control blocked with iron build-up or foreign matter	A. Increase frequency of regeneration so filter backwashes more often. NOTE: Make sure filter is sized large enough to handle water usage B. Clean inlet line. Remove piston and clean control.
6. LOSS OF MEDIA THROUGH LINE	A. Air in water system B. Backwash rate too fast	A. Assure that well system has proper air eliminator control. Check for dry well condition. B. Check drain flow control for proper flow rate

Trouble Shooting Guide - Continued

PROBLEM	CAUSE	CORRECTION
7. IRON FILTER FAILS TO DRAW CHEMICAL	A. Drain line flow control is plugged B. Injectors and/or screen plugged C. Line pressure is too low D. Internal control leak	A. Clean drain line flow control B. Clean or replace injectors and/or screen C. Maintain line pressure at 20 psi (139.9 kPa) minimum D. Change seals and spacers and/or piston assembly
8. DRAIN FLOWS CONTINUOUSLY	A. Foreign material in control B. Internal control leak C. Control valve jammed in brine or backwash position D. Timer motor stopped or jammed	A. Remove piston assembly and inspect bore, remove foreign material and check control in various regeneration positions B. Change seals and spacers and/or piston assembly C. Replace piston and seals and spacers (and drive motor if necessary) D. Replace timer motor
9. PINK COLOR (POTASSIUM PERMANGANATE) PRESENT AFTER REGENERATION MEDICINAL WATER TASTE	A. Poor water pressure or insufficient pump capacity B. Chemical in water supply	A. Be sure pump is set at 20 psi (139.9 kPa) minimum and is capable of producing 5 - 12 USGPM according to filter size B. Decrease frequency of regeneration

Guarantee

Novatek guarantees that your new water conditioner is built of quality material and workmanship. When properly installed and maintained, it will give years of trouble free service.

Seven Year Complete Parts Guarantee:

Novatek will replace any part which fails within 84 months from date of manufacture, as indicated by the serial number provided the failure is due to a defect in material or workmanship. The only exception shall be when proof of purchase or installation is provided and then the warranty period shall be from the date thereof.

Lifetime Guarantee on Mineral Tanks and Brine Tanks:

Novatek will provide a replacement mineral tank or brine tank to any original equipment purchaser in possession of a tank that fails within his/her lifetime, provided that the water conditioner is at all times operated in accordance with specifications and not subject to freezing.

General Provisions:

Novatek assumes no responsibility for consequential damage, labor or expense incurred as a result of a defect or for failure to meet the terms of these guarantees because of circumstances beyond its control.

NOVATEK